

**9105 / 9107  
Dry-well Calibrator  
User's Guide**

---

© Copyright, 1991–2002

Hart Scientific, Inc.  
799 E. Utah Valley Drive  
American Fork, Utah 84003-9775  
Telephone: (801) 763-1600 • Fax: (801) 763-1010  
Internet: <http://www.hartscientific.com>  
E-mail: [support@hartscientific.com](mailto:support@hartscientific.com)

Rev. 2A2801

# Table of Contents

<b>1</b>	<b>Before You Start</b>	<b>1</b>
1.1	Symbols Used	1
1.2	Safety Information	2
1.2.1	Warnings	2
1.2.2	Cautions	4
1.3	Hart Scientific Authorized Service Centers	5
<b>2</b>	<b>Introduction</b>	<b>7</b>
<b>3</b>	<b>Specifications and Environmental Conditions</b>	<b>9</b>
3.1	Specifications	9
3.2	Environmental Conditions	9
3.3	Warranty	10
<b>4</b>	<b>Safety Guidelines</b>	<b>11</b>
<b>5</b>	<b>Quick Start</b>	<b>13</b>
5.1	Unpacking	13
5.2	Set-up	13
5.3	Power	13
5.4	Setting the Temperature	14
<b>6</b>	<b>Parts and Controls</b>	<b>15</b>
6.1	Rear Panel	15
6.2	Front Panel	16
6.3	Constant Temperature Block Assembly	17
6.3.1	Constant Temperature Block	17
6.3.2	Probe Sleeves and Tongs	17
6.4	Well Insulator (9107 only)	18
<b>7</b>	<b>General Operation</b>	<b>21</b>
7.1	Calibrator Set-Up	21
7.2	Switching to 230 V Operation (9107 only)	21
7.3	Setting the Temperature	22
7.4	Calibrating Probes	22

<b>8</b>	<b>Controller Operation . . . . .</b>	<b>23</b>
8.1	Well Temperature. . . . .	23
8.2	Reset Cut-out . . . . .	23
8.3	Temperature Set-point . . . . .	25
8.3.1	Programmable Set-points . . . . .	25
8.3.2	Set-point Value . . . . .	26
8.3.3	Temperature Scale Units . . . . .	26
8.4	Scan . . . . .	26
8.4.1	Scan Control . . . . .	27
8.4.2	Scan Rate. . . . .	27
8.5	Temperature Display Hold . . . . .	27
8.5.1	Hold Temperature Display. . . . .	28
8.5.2	Mode Setting . . . . .	28
8.5.3	Scan Hold. . . . .	29
8.5.4	Switch Wiring . . . . .	29
8.5.5	Switch Test Example. . . . .	29
8.6	Ramp and Soak Program Menu. . . . .	31
8.6.1	Number of Program Set-points . . . . .	31
8.6.2	Set-points. . . . .	32
8.6.3	Program Soak Time. . . . .	32
8.6.4	Program Function Mode. . . . .	33
8.6.5	Program Control . . . . .	33
8.7	Secondary Menu . . . . .	34
8.8	Heating Power . . . . .	34
8.9	Proportional Band . . . . .	34
8.10	Cut-out. . . . .	36
8.11	Controller Configuration . . . . .	37
8.11.1	Probe Parameters . . . . .	37
8.11.1.1	R <sub>0</sub> . . . . .	37
8.11.1.2	ALPHA. . . . .	38
8.11.1.3	DELTA . . . . .	38
8.11.1.4	BETA . . . . .	38
8.11.2	Operating Parameters . . . . .	38
8.11.2.1	Temperature Scale Units . . . . .	38
8.11.2.2	Cut-out Reset Mode . . . . .	38
8.11.2.3	Soak Stability . . . . .	39
8.11.3	Serial Interface Parameters . . . . .	39
8.11.3.1	BAUD Rate . . . . .	39
8.11.3.2	Sample Period. . . . .	40
8.11.3.3	Duplex Mode . . . . .	40
8.11.3.4	Linefeed. . . . .	40
8.11.4	IEEE-488 Parameters . . . . .	41
8.11.4.1	IEEE-488 Address . . . . .	41
8.11.4.2	Termination . . . . .	41
8.11.5	Calibration Parameters . . . . .	42
8.11.5.1	CTO . . . . .	42
8.11.5.2	BO and BG . . . . .	42

8.11.5.3SCO . . . . .	42
<b>9 Digital Communication Interface . . . . .</b>	<b>43</b>
9.1 Serial Communications . . . . .	43
9.1.1 Wiring . . . . .	43
9.1.2 Setup . . . . .	43
9.1.2.1 BAUD Rate . . . . .	44
9.1.2.2 Sample Period . . . . .	44
9.1.2.3 Duplex Mode . . . . .	44
9.1.2.4 Linefeed . . . . .	44
9.1.3 Serial Operation . . . . .	45
9.2 IEEE-488 Communication . . . . .	45
9.2.1 Setup . . . . .	45
9.2.1.1 IEEE-488 Interface Address . . . . .	45
9.2.2 IEEE-488 Operation . . . . .	45
9.3 Interface Commands . . . . .	46
<b>10 Test Probe Calibration . . . . .</b>	<b>51</b>
10.1 Comparison Methods . . . . .	51
10.1.1 Direct Calibration . . . . .	51
10.1.2 Comparison Calibration . . . . .	51
10.1.3 Calibration of Multiple Probes . . . . .	52
10.2 Dry-Well Characteristics . . . . .	52
10.2.1 Vertical Gradient . . . . .	53
10.2.2 Stabilization and Accuracy . . . . .	53
<b>11 Calibration Procedure . . . . .</b>	<b>55</b>
11.1 Calibration Procedure . . . . .	55
11.1.1 Calibration Equipment . . . . .	55
11.1.2 Calibration . . . . .	55
<b>12 Maintenance . . . . .</b>	<b>57</b>
<b>13 Troubleshooting . . . . .</b>	<b>59</b>
13.1 Troubleshooting . . . . .	59
13.2 Comments . . . . .	60
13.2.1 EMC Directive . . . . .	60
13.2.2 Low Voltage Directive (Safety) . . . . .	60
13.3 Wiring Diagrams . . . . .	61

# Figures

- Figure 1 Top View . . . . . 3
- Figure 2 Rear Panel . . . . . 15
- Figure 3 Front Panel . . . . . 16
- Figure 4 Well and Insert . . . . . 17
- Figure 5 Well Insulator Top View . . . . . 19
- Figure 6 Controller Function Flowchart . . . . . 24
- Figure 7 Switch Test Data . . . . . 31
- Figure 8 Well temperature fluctuation at various proportional band settings . . . . . 35
- Figure 9 Serial Cable Wiring Diagram . . . . . 43
- Figure 10 9105 Wiring Diagram . . . . . 61
- Figure 11 9107 Wiring Diagram . . . . . 62

# Tables













Table 1	International Electrical Symbols . . . . .	1
Table 2	Communications Commands . . . . .	47
Table 2	Communications Commands Continued . . . . .	48
Table 2	Communications Commands Continued . . . . .	49

# 1 Before You Start



## 1.1 Symbols Used

Table 1 lists the symbols used on the instrument or in this manual and the meaning of each symbol.

**Table 1** International Electrical Symbols

Symbol	Description
	AC (Alternating Current)
	AC-DC
	Battery
	Complies with European Union directives
	DC
	Double Insulated
	Electric Shock
	Fuse
	PE Ground
	Hot Surface (Burn Hazard)
	Read the User's Manual (Important Information)
	Off
	On



Symbol	Description
	Canadian Standards Association
CAT II	OVERVOLTAGE (Installation) CATEGORY II, Pollution Degree 2 per IEC1010-1 refers to the level of Impulse Withstand Voltage protection provided. Equipment of OVERVOLTAGE CATEGORY II is energy-consuming equipment to be supplied from the fixed installation. Examples include household, office, and laboratory appliances.
	C-TIC Australian EMC

## 1.2 Safety Information

Use the instrument only as specified in this manual. Otherwise, the protection provided by the instrument may be impaired. Refer to the safety information below and throughout the manual.

The following definitions apply to the terms “Warning” and “Caution”.

- “Warning” identifies conditions and actions that may pose hazards to the user.
- “Caution” identifies conditions and actions that may damage the instrument being used.

### 1.2.1



#### Warnings

To avoid possible electric shock or personal injury, follow these guidelines.

- **BURN HAZARD – Do Not touch the well access surface of the unit.** (Refer to Figure 1 on page 3.)
- The temperature of the well access (1) will be the same as the actual temperature shown on the display (2), e.g. if the unit is set at 600°C and the display reads 600°C, the well is at 600°C.
- The top sheet metal (3) of the dry-well may exhibit extreme temperatures for areas close to the well access.
- The air over the well can reach temperatures greater than 200°C.  
**PROBES SHOULD ONLY BE INSERTED AND REMOVED FROM THE UNIT WHEN THE UNIT IS SET AT TEMPERATURES LESS THAN 200°C.**
- **DO NOT TURN OFF THE UNIT AT TEMPERATURES HIGHER THAN 100°C.** This could create a hazardous situation. Select a set-point less than 100°C and allow the unit to cool before turning it off.

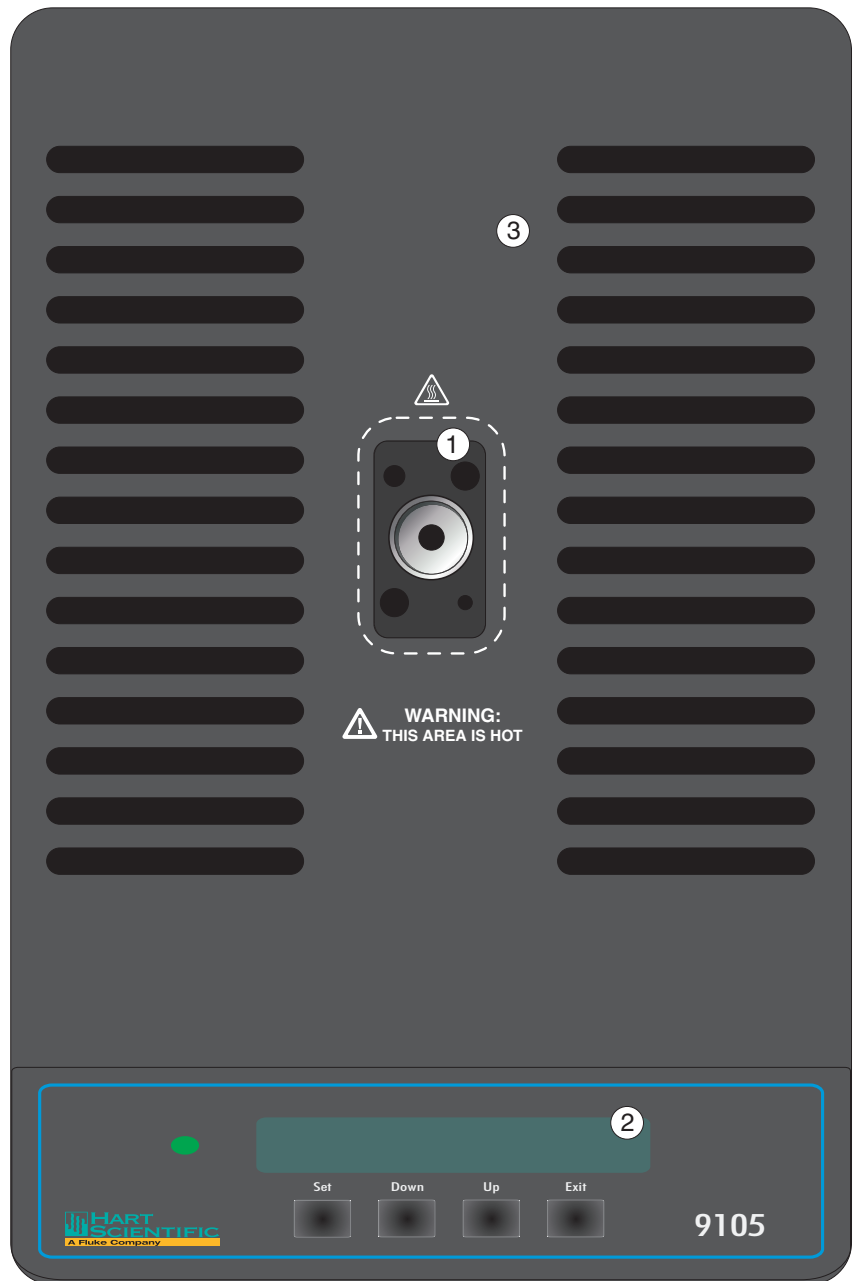

Figure 1 Top View

- **DO NOT REMOVE INSERTS AT HIGH TEMPERATURES.** Inserts will be the same temperature as the display temperature. Use extreme care when removing hot inserts.
- **DO NOT** operate this unit without a properly grounded, properly polarized power cord.
- **DO NOT** connect this unit to a non-grounded, non-polarized outlet.
- **HIGH VOLTAGE** is used in the operation of this equipment. **SEVERE INJURY OR DEATH** may result if personnel fail to observe safety precautions. Before working inside the equipment, turn power off and disconnect power cord.
- Always replace the fuse with one of the same rating, voltage, and type.
- Overhead clearance is required. **DO NOT** place unit under a cabinet or other structure.
- **DO NOT** use this unit for any application other than calibration work.
- **DO NOT** use this unit in environments other than those listed in the user's manual.
- **DO NOT** turn the unit upside down with the inserts in place; the inserts will fall out of the unit.
- **DO NOT** operate near flammable materials.
- Use of this instrument at **HIGH TEMPERATURES** for extended periods of time requires caution.
- Completely **unattended high temperature operation is not recommended** for safety reasons.
- Before initial use, after transport and anytime the dry-well has not been energized for more than 10 days, the calibrator must be energized for a dry-out period of 1 to 2 hours before it can be assumed to meet all of the safety requirements of the IEC1010-1.
- Follow all safety guidelines listed in the user's manual.
- CALIBRATION EQUIPMENT should only be used by TRAINED PERSONNEL.

## 1.2.2



### Cautions

To avoid possible damage to the instrument, follow these guidelines.

- Components and heater lifetime can be shortened by continuous high temperature operation.

- Components and heater lifetime can be shortened by continuous high temperature operation.
- Most probes have handle temperature limits. Be sure that the probe handle temperature limit is not exceeded in the air above the unit.
- (9107 only) Always use the well insulator, see Section 5.4.
- Allow for test probe expansion inside the well as the dry-well heats.
- **DO NOT** use fluids to clean out the well.
- **Never introduce any foreign material** into the probe hole of the insert. Fluids, etc. can leak into the calibrator causing damage.
- **DO NOT** change the values of the calibration constants from the factory set values. The correct setting of these parameters is important to the safety and proper operation of the calibrator.
- **DO NOT** slam the probe stems in to the well. This type of action can cause a shock to the sensor and affect the calibration.
- **DO** use a ground fault interrupt device.

## 1.3 Hart Scientific Authorized Service Centers

Please contact one of the following authorized Service Centers to coordinate service on your Hart product:

### **Hart Scientific, Inc.**

799 E. Utah Valley Drive  
American Fork, UT 84003-9775  
USA

Phone: +1.801.763.1600

Telefax: +1.801.763.1010

E-mail: [support@hartscientific.com](mailto:support@hartscientific.com)

### **Fluke Nederland B.V.**

Customer Support Services  
Science Park Eindhoven 5108  
5692 EC Son  
NETHERLANDS

Phone: +31-402-675300

Telefax: +31-402-675321

E-mail: ServiceDesk@fluke.nl

**Fluke Int'l Corporation**

Service Center - Instrimpex

Room 2301 Sciteck Tower

22 Jianguomenwai Dajie

Chao Yang District

Beijing 100004, PRC

CHINA

Phone: +86-10-6-512-3436

Telefax: +86-10-6-512-3437

E-mail: xingye.han@fluke.com.cn

**Fluke South East Asia Pte Ltd.**

Fluke ASEAN Regional Office

Service Center

83 Clemenceau Avenue

#15-15/06 Ue Square

239920

SINGAPORE

Phone: +65-737-2922

Telefax: +65-737-5155

E-mail: antng@singa.fluke.com

When contacting these Service Centers for support, please have the following information available:

- Model Number
- Serial Number
- Voltage
- Complete description of the problem

## 2 Introduction

The Hart Scientific Model 9105/9107 dry-well calibrator may be used as a portable instrument for calibration of temperature probes. The 9105 operates over the range of  $-25^{\circ}\text{C}$  and  $140^{\circ}\text{C}$ . The 9107 operates over the range of  $-45^{\circ}\text{C}$  to  $140^{\circ}\text{C}$ .

These dry-well calibrators feature an interchangeable aluminum probe sleeve along with 4 fixed wells. The temperature is accurately controlled by Hart's precision temperature controller.

The calibrator controller uses a precision platinum RTD as a sensor and controls the well temperature with thermoelectric modules. The LED front panel display continuously shows the current well temperature. The temperature may be easily set with the control buttons to any desired temperature within the specified range.

The 9105/9107 dry-well calibrator was designed for portability, moderate cost, and ease of operation. With proper use the instrument should provide continued accurate calibration of temperature sensors and devices. The user should be familiar with the safety guidelines and operating procedures of the calibrator as described in the User's Guide.

## 3 Specifications and Environmental Conditions

### 3.1 Specifications

The following table lists the specifications for this instrument. Accuracy specifications are applicable for a one-year calibration interval. In line with normal prudent metrology practices, Hart Scientific recommends a short-cycle interval of six months for new units during the first year.

	9105	9107
<b>Power</b>	115 VAC ( $\pm 10\%$ ), 50/60 Hz, 230 VAC ( $\pm 10\%$ ), 350 watts	
<b>Ambient Temperature</b>	5–50°C (40–120°F)	
<b>Operating Range</b>	–25°C to 140°C (–32°C to 284°F) at 25°C (77°F)	–45°C to 140°C (–49°F to 285°F) at 25°C (77°F)
<b>Resolution</b>	0.01°C or 0.01°F	
<b>Accuracy:</b>	$\pm 0.2^\circ\text{C}$ (0.36°F)	
<b>Drilled Wells</b>		
<b>Center Well</b>	$\pm 0.1^\circ\text{C}$ (0.18°F) with 6.35 mm (1/4") probe	
<b>Uniformity:</b>	$\pm 0.05^\circ\text{C}$ (0.09°F)	
<b>Drilled Wells</b>		
<b>Center Well</b>	$\pm 0.2^\circ\text{C}$ (0.36°F) with 6.35 (1/4") mm probe	
<b>Control Stability</b>	$\pm 0.02^\circ\text{C}$ (0.04°F)	
<b>Controller</b>	Hybrid analog/digital controller with data retention	
<b>Test Wells</b>	One 3/4" dia. x 6" deep, two 1/4" dia. x 6", one 3/16" dia. x 6" deep, and one 1/8" x 6" deep	
<b>Size</b>	12.5" H x 8" W x 10.5" D	
<b>Weight</b>	30 lb. including well sleeve	
<b>Safety</b>	OVERVOLTAGE (Installation) CATEGORY II, Pollution Degree 2 per IEC1010-1	
<b>Fuse Rating</b>	115 V: 4 A (slow blow) 250 V 230 V: 3.15 A (slow blow) 250 V	

### 3.2 Environmental Conditions

Although these instruments have been designed for optimum durability and trouble-free operation, they must be handled with care. The instrument should not be operated in an excessively dusty or dirty environment. Maintenance and cleaning recommendations can be found in the Maintenance Section of this manual.

The instrument operates safely under the following conditions:

- temperature range 5 - 50°C (41 - 122°F)
- ambient relative humidity 15 - 50%
- pressure - 75kPa - 106kPa
- mains voltage within  $\pm 10\%$  of nominal
- vibrations in the calibration environment should be minimized
- altitude less than 2,000 meters

### 3.3 Warranty

Hart Scientific, Inc. (Hart) warrants this product to be free from defects in material and workmanship under normal use and service for a period as stated in our current product catalog from the date of shipment. This warranty extends only to the original purchaser and shall not apply to any product which, in Hart's sole opinion, has been subject to misuse, alteration, abuse or abnormal conditions of operation or handling.

Software is warranted to operate in accordance with its programmed instructions on appropriate Hart products. It is not warranted to be error free.

Hart's obligation under this warranty is limited to repair or replacement of a product which is returned to Hart within the warranty period and is determined, upon examination by Hart, to be defective. If Hart determines that the defect or malfunction has been caused by misuse, alteration, abuse or abnormal conditions or operation or handling, Hart will repair the product and bill the purchaser for the reasonable cost of repair.

To exercise this warranty, the purchaser must forward the product after calling or writing Hart for authorization. Hart assumes NO risk for in-transit damage.

For service or assistance, please contact a Hart Scientific Authorized Customer Service Center (see Section 1.3).

THE FOREGOING WARRANTY IS PURCHASER'S SOLE AND EXCLUSIVE REMEDY AND IS IN LIEU OF ALL OTHER WARRANTIES, EXPRESS OR IMPLIED, INCLUDING BUT NOT LIMITED TO ANY IMPLIED WARRANTY OR MERCHANTABILITY, OR FITNESS FOR ANY PARTICULAR PURPOSE OR USE. HART SHALL NOT BE LIABLE FOR ANY SPECIAL, INDIRECT, INCIDENTAL, OR CONSEQUENTIAL DAMAGES OR LOSS WHETHER IN CONTRACT, TORT, OR OTHERWISE.



## 4 Safety Guidelines

- Operate the instrument in room temperatures between 5–50°C (41–122°F). Allow sufficient air circulation by leaving at least 6 inches of space between the instrument and nearby objects. **DO NOT** place under a cabinet or other structure. Allow for overhead clearance.
- The dry-well is a precision instrument. Although it has been designed for optimum durability and trouble free operation, it must be handled with care. Always carry the unit in an upright position to prevent the probe sleeves from dropping out. The convenient fold-up handle allows one hand carrying. The instrument should not be operated in excessively wet, oily, dusty, or dirty environments. It is important to keep the well of the instrument clean and clear of any foreign matter. **DO NOT** operate near flammable materials.
- **DO NOT** use fluids to clean out the well.
- The instrument can generate extreme temperatures. Precautions must be taken to prevent personal injury or damage to objects. Probes may be extremely hot or cold when removed from the instrument. Cautiously handle probes to prevent personal injury. Always use the special sleeve tongs that are supplied with the calibrator to remove the sleeve. Carefully place probes on a heat/cold resistant surface or rack until they are at room temperature. Never place any objects other than the special probe sleeves supplied with the calibrator into the well.
- Use only a grounded AC mains supply of the appropriate voltage to power the instrument. The Model 9105 dry-well requires 3 amps SB at 115 VAC ( $\pm 10\%$ ), 50/60 Hz, 1.6 amps T at 230 VAC ( $\pm 10\%$ ). The Model 9107 dry-well requires 4 amps SB at 115 VAC ( $\pm 10\%$ ), 50/60 Hz, 3.15 amps T at 230 VAC ( $\pm 10\%$ ).
- Before initial use, after transport, and anytime the dry-well has not been energized for more than 10 days, the instrument needs to be energized for a “dry-out” period of 1-2 hours before it can be assumed to meet all of the safety requirements of the IEC 1010-1.
- The instrument is equipped with operator accessible fuses. If a fuse blows, it may be due to a power surge or failure of a component. Replace the fuse once. If the fuse blows a second time, it is likely caused by failure of a component part. If this occurs, contact Hart Scientific Customer Service. Always replace the fuse with one of the same rating, voltage, and type. Never replace the fuse with one of a higher current rating.
- If a mains supply power fluctuation occurs, immediately turn off the instrument. Power bumps from brown-outs and black-outs could damage

the instrument. Wait until the power has stabilized before re-energizing the instrument.

## 5 Quick Start

### 5.1 Unpacking

Unpack the dry-well carefully and inspect it for any damage that may have occurred during shipment. If there is shipping damage, notify the carrier immediately.

Verify that the following components are present:

- 9105 or 9107 Dry-well
- 2173 Insert, 1/4" Aluminum
- Power Cord
- Manual
- Two Well Insulators (9107 only)
- Tongs (insert removal tool)

### 5.2 Set-up

Place the calibrator on a flat surface with at least 6 inches of free space around the instrument. Overhead clearance is required. **DO NOT** place under a cabinet or structure. Plug the power cord into a grounded mains outlet. Observe that the nominal voltage corresponds to that indicated on the back of the calibrator.

Carefully insert the probe sleeve into the well. Probe sleeves should be of the smallest hole diameter possible still allowing the probe to slide in and out easily. Sleeves of various sizes are available for Hart Scientific. The well must be clear of any foreign objects, dirt and grit before the sleeve is inserted. The sleeve is inserted with the two small tong holes positioned upward.

Turn on the power to the calibrator by toggling the switch on the power entry module. The fan should begin quietly blowing air through the instrument and the controller display should illuminate after 3 seconds. After a brief self-test the controller should begin normal operation. If the unit fails to operate please check the power connection.

The display will begin to show the well temperature and the well heater will start operating to bring the temperature of the well to the set-point temperature.

### 5.3 Power

Plug the dry-well power cord into a mains outlet of the proper voltage, frequency, and current capability. Typically this will be 115 VAC ( $\pm 10\%$ ), 50/60 Hz (230 VAC  $\pm 10\%$ , 50/60 Hz). Turn the dry-well on using the rear panel

“POWER” switch. The dry-well will turn on and begin to heat to the previously programmed temperature set-point. The front panel LED display will indicate the actual dry-well temperature.

The 9107 is field switchable between 115 V and 230 V. Refer to Section 7.2, Switching to 230 V Operation, for information on switching the voltage.

## 5.4 Setting the Temperature

Section 8.3 explains in detail how to set the temperature set-point on the calibrator using the front panel keys. The procedure is summarized here.

1. Press “SET” twice to access the set-point value.
2. Press “UP” or “DOWN” to change the set-point value.
3. Press “SET” to program in the new set-point.
4. Press “EXIT” to return to the temperature display.

When the set-point temperature is changed the controller will switch the well heater on or off to raise or lower the temperature. The displayed well temperature will gradually change until it reaches the set-point temperature. The well may require 5 to 10 minutes to reach the set-point depending on the span. Another 5 to 10 minutes is required to stabilize with  $\pm 0.1^{\circ}\text{C}$  of the set-point. Ultimate stability may take 15 to 20 minutes more of stabilization time.

## 6 Parts and Controls

The user should become familiar with the dry-well calibrator and its parts.

### 6.1 Rear Panel

See Figure 2.

**Power Cord** - At the rear of the calibrator is the removable power cord that plugs into a standard 115 VAC grounded socket. (230 VAC optional.)

**Power Switch (9105)** - The power switch is located on the rear panel of the calibrator.



Figure 2 Rear Panel

**Power Entry Module (9107)** - The power switch is located on the power entry module (PEM). The PEM also houses the fuses. The supply voltage for the unit is indicated on the PEM.

**Serial Port** - This D-9 connector is for interfacing the calibrator to a computer or terminal with serial RS-232 communications.

**Display Hold** - The two terminals may be used to wire a switch or cut-out to the calibrator to trigger the instrument to freeze the displayed well temperature.

**Fuse Holders** - At the rear of the calibrator are two user accessible fuse holders.

## 6.2 Front Panel

See Figure 3 on page 16.

**Controller Display** - The digital display is an important part of the temperature controller because it not only displays set and actual temperatures but also various calibrator functions, settings, and constants. The display shows temperatures in units according to the selected scale °C or °F.

**Controller Keypad** - The four button keypad allows easy setting of the set-point temperature. The control buttons (SET, DOWN, UP, and EXIT) are used to set the calibrator temperature set-point, access and set other operating parameters, and access and set calibration parameters.

Setting the control temperature is done directly in degrees of the current scale. It can be set to one-hundredth of a degree Celsius.

The functions of the buttons are as follows:

SET – Used to display the next parameter in the menu and to set parameters to the displayed value.

DOWN – Used to decrement the displayed value of parameters.



**Figure 3** Front Panel

UP – Used to increment the displayed value.

EXIT – Used to exit from a menu. When EXIT is pressed any changes made to the displayed value will be ignored.

**Control Indicator** - The Control Indicator is a two color light emitting diode. This indicator lets the user visually see the ratio of heating to cooling. When the indicator is constant red the well is heating, and when it is constant green the well is cooling. When the indicator is flashing then the temperature is being held constant.

## 6.3 Constant Temperature Block Assembly

### 6.3.1 Constant Temperature Block

The block, Figure 4, is made of aluminum and provides a relatively constant and accurate temperature environment in which the sensors that are to be calibrated are inserted. The .75 inch diameter hole in the center of the block may be used for sensors of that size or sleeved down with various sized probe sleeves. The block also has 4 smaller holes of various sizes. Attached to the block are Peltier thermoelectric modules which heat or cool the block to maintain a constant temperature. A high-quality platinum RTD is imbedded in the block to sense the temperature and provide feedback to the temperature controller.

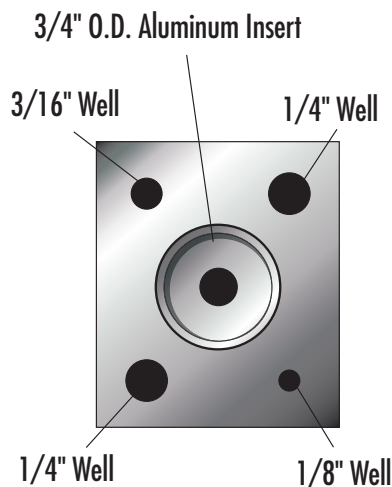

**Figure 4** Well and Insert

### 6.3.2 Probe Sleeves and Tongs

Probe sleeves of various internal hole sizes are available to allow the user's probe to fit snugly into the well whatever the diameter of the probe.

Standard Insert Sizes	
Model Number	Size
2168	Blank insert
2169	$\frac{1}{16}$ $\phi$ insert
2170	$\frac{1}{8}$ $\phi$ insert
2171	$\frac{5}{32}$ $\phi$ insert
2172	$\frac{3}{16}$ $\phi$ insert
2173	$\frac{1}{4}$ $\phi$ insert
2174	$\frac{5}{16}$ $\phi$ insert
2175	$\frac{3}{8}$ $\phi$ insert
2176	$\frac{1}{2}$ $\phi$ insert
2177	$\frac{5}{8}$ $\phi$ insert
2178	$\frac{7}{16}$ $\phi$ insert
2179	$\frac{9}{16}$ $\phi$ insert

## 6.4 Well Insulator (9107 only)

The 9107 includes a well insulator made of white polymer foam that fits into the opening above the block (see Figure 5). The well insulator has three purposes:

1. Insulate the top of the block to minimize the vertical temperature gradient in the block.
2. Insulate the top of the block to prevent excessive heat from flowing into or out of the block which may prevent it from reaching its minimum or maximum temperatures.
3. Shield the top of the block from open air thus reducing the potential for excessive water condensation on the block. Excessive water on the block can cause corrosion over a long period of time. Water condensation that freezes expands and can damage the block.

For these reasons the 9107 must always have the well insulator installed when it is operated with well temperatures below 25°C. The well insulator fits snugly into the circular cavity just above the block. For best results do not push the well insulator all the way down into the cavity. Instead, leave the top of the well



insulator flush with the top of the cavity. The well insulator has a slot through which a probe can be inserted.

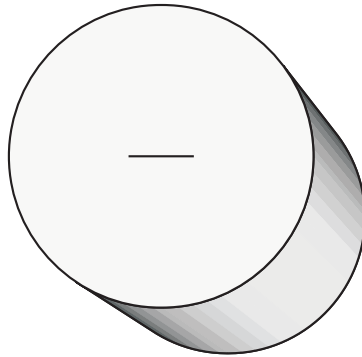

**Figure 5** *Well Insulator Top View*

## 7 General Operation

### 7.1 Calibrator Set-Up

Place the calibrator on a flat surface with at least 6 inches of free space around the instrument. Overhead clearance is required. **DO NOT** place under a cabinet or other structure. Plug the power cord into a grounded mains outlet. Observe that the nominal voltage corresponds to that indicated on the back of the calibrator.

Gently insert the probe sleeve into the well. The probe sleeve should be of the smallest hole size possible while allowing the probe to slide in and out easily. Sleeves of various sizes are available from the manufacturer. The well must be clear of any foreign objects, dirt and grit before the sleeve is inserted. The sleeve is inserted with the two small tong holes positioned upward.

Turn on the power to the calibrator by toggling the switch at the rear of the instrument to the “I” (on) position. The fan will begin circulating air through the instrument. After a brief self test the controller should begin normal operation showing the well temperature. The block will heat or cool until it reaches the programmed set-point.

### 7.2 Switching to 230 V Operation (9107 only)

To change the mains voltage on the 9107 perform the following steps.

1. Unplug the unit from the power source.
2. Insert a flat-headed screwdriver into the slot on the PEM.
3. Remove the fuse holder from the PEM.
4. Change the fuses to the appropriate current rating for the voltage (see Section 4, Safety Guidelines).
5. Replace fuse holder with the appropriate voltage displayed through the window of the PEM.
6. The power cord may need to be changed to mate with the appropriate 230 VAC or 115 VAC socket. Some options are listed.
  - 230 VAC: Europe – 10A approved cord with CEE 717 plug  
US – 15A approved cord with a NEMA 6-15 straight blade plug
  - 115 VAC: US – 15A approved cord with a NEMA 5-15 plug.

## 7.3 Setting the Temperature

Section 8.3 explains in detail how to set the temperature set-point on the calibrator using the front panel keys. The procedure is summarized here.

- (1) Press “SET” twice to access the set-point value.
- (2) Press “UP” or “DOWN” to change the set-point value.
- (3) Press “SET” to program in the new set-point.
- (4) Press “EXIT” to return to the temperature display.

When the set-point temperature is changed the controller will switch the well heater on or off to raise or lower the temperature. The cycle indicator, a two color LED, will also indicate on (red and heating) or off (green and cooling). The displayed well temperature will gradually change until it reaches the set-point temperature. The well may require 5 to 20 minutes to reach the set-point depending on the span. Another 5 to 10 minutes is required for the temperature to stabilize.

## 7.4 Calibrating Probes

The dry-well block provides a constant temperature environment in which probes may be compared. The probes inserted into the block may be compared to the well temperature displayed on the front panel of the calibrator. The probes should be inserted the full depth of the well since the temperature at the bottom of the well will most closely agree with the displayed temperature.

For greater accuracy the probes may be compared to a reference thermometer inserted into the block. The reference thermometer may be inserted into one hole while the probes to be calibrated are inserted into another. The drawback to this method is that because of temperature variations throughout the block there may be a small temperature difference between one hole and another which can cause errors.

Using the same hole for the reference thermometer and the test probe may have better results. This however requires switching the probes which takes more time. One must allow a few minutes after inserting the probes for the temperature to stabilize before making measurements. Because of temperature variations along the length of the well, best results are obtained when comparing probes of similar construction and inserting them the same depth into the well.

## 8 Controller Operation

This chapter discusses in detail how to operate the dry-well temperature controller using the front control panel. Using the front panel key-switches and LED display the user may monitor the well temperature, set the temperature set-point in degrees C or F, monitor the heater output power, adjust the controller proportional band, set the cut-out set-point, and program the probe calibration parameters, operating parameters, serial and IEEE-488 interface configuration, and controller calibration parameters. Operation of the functions are summarized in Figure 6 on page 24.

In the following discussion a solid box around the word SET, UP, EXIT or DOWN indicates the panel button while the dotted box indicates the display reading. Explanation of the button or display reading are to the right of each button or display value.

### 8.1 Well Temperature

The digital LED display on the front panel allows direct viewing of the actual well temperature. This temperature value is what is normally shown on the display. The units, C or F, of the temperature value are displayed at the right. For example,

20.00 C *Well temperature in degrees Celsius*

The temperature display function may be accessed from other functions by pressing the “EXIT” button.

### 8.2 Reset Cut-out

If the over-temperature cut-out has been triggered then the temperature display will alternately flash,

c u t - o u t *Indicates cut-out condition*

The message will continue to flash until the temperature is reduced and the cut-out is reset.

The cut-out has two modes — automatic reset and manual reset. (See Section 8.11.2.2) The mode determines how the cut-out is reset which allows the instrument to heat up again. When in automatic mode, the cut-out will reset itself as soon as the temperature is lowered below the cut-out set-point. With manual reset mode the cut-out must be reset by the operator after the temperature falls below the set-point.

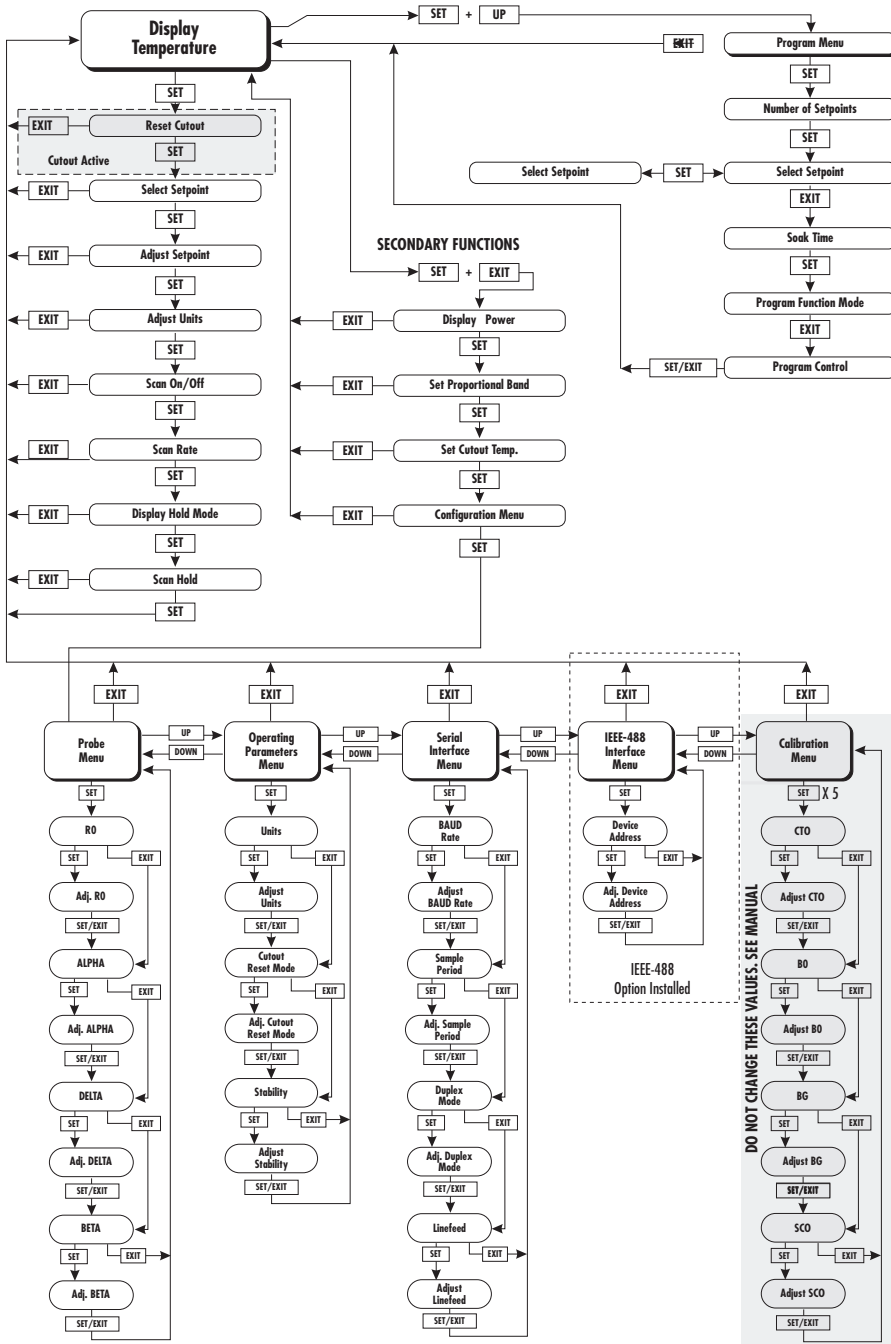

Figure 6 Controller Function Flowchart

When the cut-out is active and the cut-out mode is set to manual (“reset”) then the display will flash “cut-out” until the user resets the cut-out. To access the reset cut-out function press the “SET” button.



*Access cut-out reset function*

The display will indicate the reset function.



*Cut-out reset function*

Press “SET” once more to reset the cut-out.



*Reset cut-out*

This will also switch the display to the set temperature function. To return to displaying the temperature press the “EXIT” button. If the cut-out is still in the over-temperature fault condition the display will continue to flash “cut-out”. The well temperature must drop a few degrees below the cut-out set-point before the cut-out can be reset.

## 8.3 Temperature Set-point

The temperature set-point can be set to any value within the range and with resolution as given in the specifications. Be careful not to exceed the safe upper temperature limit of any device inserted into the well. The safety cut-out should be properly adjusted to help prevent this occurrence.

Setting the temperature involves two steps: (1) select the set-point memory and (2) adjust the set-point value.

### 8.3.1 Programmable Set-points

The controller stores 8 set-point temperatures in memory. The set-points can be quickly recalled to conveniently set the calibrator to a previously programmed temperature set-point.

To set the temperature one must first select the set-point memory. This function is accessed from the temperature display function by pressing “SET”. The number of the set-point memory currently being used is shown at the left on the display followed by the current set-point value.

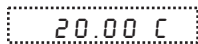

*Well temperature in degrees Celsius*



*Access set-point memory*

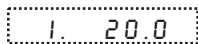

*Set-point memory 1, 20.0°C currently used*

To change the set-point memory press “UP” or “DOWN”.

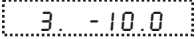
 *New set-point memory 3, -10.0°C*

Press “SET” to accept the new selection and access the set-point value.



*Accept selected set-point memory*

### 8.3.2 Set-point Value

The set-point value may be adjusted after selecting the set-point memory and pressing “SET”. The set-point value is displayed with the units, C or F, at the left.

 *Set-point 3 value in °C*

If the set-point value need not be changed then press “EXIT” to resume displaying the well temperature. Press “UP” or “DOWN” to adjust the set-point value.

 *New set-point value*

When the desired set-point value is reached press “SET” to accept the new value and access the temperature scale units selection. If “EXIT” is pressed instead then any changes made to the set-point will be ignored.



*Accept new set-point value*

### 8.3.3 Temperature Scale Units

The temperature scale units of the controller maybe set by the user to degrees Celsius (°C) or Fahrenheit (°F). The units are used in displaying the well temperature, set-point, and proportional band.

Press “SET” after adjusting the set-point value to change display units.

 *Scale units currently selected*

Press “UP” or “DOWN” to change the units.

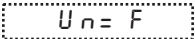
 *New units selected*

## 8.4 Scan

The scan rate can be set and enabled so that when the set-point is changed the dry-well will heat or cool at a specified rate (degrees per minute) until it

reaches the new set-point. With the scan disabled the dry-well will heat or cool at the maximum possible rate.

### 8.4.1 Scan Control

The scan is controlled with the scan on/off function that appears in the main menu after the set-point function.

 *Scan function off*

Press “UP” or “DOWN” to toggle the scan on or off.

 *Scan function on*

Press “SET” to accept the present setting and continue.



*Accept scan setting*

### 8.4.2 Scan Rate

The next function in the main menu is the scan rate. The scan rate can be set from .1 to 100 °C/min. The maximum scan rate however is actually limited by the natural heating or cooling rate of the instrument. This is often less than 100 °C/min, especially when cooling.

The scan rate function appears in the main menu after the scan control function. The scan rate units are in degrees per minute, degrees C or F depending on the selected units.

 *Scan rate in °C/min*

Press “UP” or “DOWN” to change the scan rate.

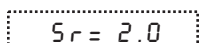
 *New scan rate*

Press “SET” to accept the new scan rate and continue.



*Accept scan rate*

## 8.5 Temperature Display Hold

The instrument has a display hold function which allows action of an external switch to freeze the displayed temperature and stop the set-point from scanning. This is useful for testing thermal switches and cut-outs. This section explains the functions available for operating the temperature hold feature. An example follows showing how to set up and use the hold feature to test a switch.



### 8.5.1 Hold Temperature Display

When the hold feature is enabled you can easily switch the display between the normal temperature display and the hold temperature display by simply pressing the “UP” or “DOWN” buttons. The hold temperature display shows the hold temperature on the right and the switch status on the left. For the status “c” means the switch is closed and “o” means the switch is open. The status flashes when the switch is in its active position (opposite the normal position). The hold temperature shows what the temperature of the well was when the switch changed from its normal position to its active position. While the switch is in the normal position the hold temperature will follow the well temperature. Operation of the hold temperature display is outlined below.

 *Well temperature display*

 *Access hold display*

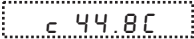
 *Switch status and hold temperature*

Note that the hold function display is not accessible if the function mode is set to “OFF”. (See Section 8.5.2)

To return to the normal well temperature display press “DOWN” or “EXIT”.

### 8.5.2 Mode Setting

The temperature hold feature has three modes of operation. In the normally-closed (n.c.) mode the hold temperature display freezes when the switch opens. In the normally-open (n.o.) mode the hold temperature display freezes when the switch closes. Whenever the switch is in the normal position the hold temperature follows the well temperature.

There is also an automatic mode. In this mode the normal position is set to whatever the switch position is when the set-point is changed. For example, if the switch is currently open when the set-point is changed, the closed position then becomes the new active position. The normal position will be set automatically under any of the following conditions, (1) a new set-point number is selected, (2) the set-point value is changed, (3) a new set-point is set through the communications channels, or (4) the ramp-and-soak program is running and automatically steps to the next set-point in the sequence. The automatic mode is useful for repetitive tests of the opening and closing temperatures of a switch.

The temperature hold feature can also be disabled by setting the mode to “OFF”.

The operating mode of the temperature hold is set in the primary menu after the scan rate setting.

`H o L d = 0 F F` *Hold mode set to off*

To change the mode press “UP” or “DOWN”.

`H o L d = A u t` *Automatic mode*

`H o L d = n . c .` *Normally closed mode*

`H o L d = n . o .` *Normally open mode*

Press “SET” to accept the displayed setting.

### 8.5.3 Scan Hold

In addition to controlling the hold temperature display, a switch can also control set-point scanning by enabling the scan hold function. When the switch changes from its normal position to its active position scanning will stop. For the scan hold to be effective scanning must be enabled and the scan rate should be set to a relatively low value (see sections 8.4.1 and 8.4.2).

The scan hold is set in the primary menu after the temperature hold mode setting.

`S H o L d = 0 F` *Scan hold set to off*

To change the mode press “UP” or “DOWN”.

`S H o L d = 0 n` *Scan hold set to on*

Press “SET” to accept the displayed setting.

### 8.5.4 Switch Wiring

The thermal switch or cut-out is wired to the calibrator at the two terminals at the back of the dry-well calibrator labeled “DISPLAY HOLD”. The switch wires may be connected to the terminals either way. Internally the black terminal connects to ground. The red terminal connects to +5V through a 10 kΩ resistor. The calibrator measures the voltage at the red terminal and interprets +5V as open and 0V as closed.

### 8.5.5 Switch Test Example

This section describes a possible application for the temperature hold feature and how the instrument is set up and operated.

Suppose you have a thermal switch which is supposed to open at about 75°C and close at about 50°C and you want to test the switch to see how accurate and repeatable it is. You can use the temperature hold feature and the ramp and

soak feature (described in detail in the next section) to test the switch. Measurements can be made by observing the display or, preferably, by collecting data using a printer or computer connected to the RS-232 port. To set up the test do the following steps.

1. Connect the switch wires to the terminals on the back of the dry-well and place the switch in the well.
2. Enable set-point scanning by setting the scan to “ON” in the primary menu (see Section 8.4.1).
3. Set the scan rate to a low value, say 1.0°C/min. (see Section 8.4.2). If the scan rate is too high you may lose accuracy because of transient temperature gradients. If the scan rate is too low the duration of the test may be longer than is necessary. You may need to experiment to find the best scan rate.
4. Set the hold mode to automatic (see Section 8.5.2).
5. Set the scan hold to “ON” (see Section 8.5.3).
6. Set the number of program set-points to 2 in the program menu (see Section 8.6.1).
7. Set the first program set-point to a value below the expected lower switch temperature, say 40°C, in the program menu (see Section 8.6.2).
8. Set the second program set-point to a value above the expected upper switch temperature, say 90°C.
9. Set the program soak time to allow enough time to collect a number of data points, say 2 minutes (see Section 8.6.3).
10. Set the program function to mode 4 so that the instrument will cycle between the 2 set-points repeatedly. (See Section 8.6.4.)
11. Start the program (see Section 8.6.5).
12. Collect data on a computer connected to the RS-232 port. Refer to Section 9 for instructions on configuring the RS-232 communications interface. The data may appear as shown in Figure 7. The maxima and minima are the switch temperatures.

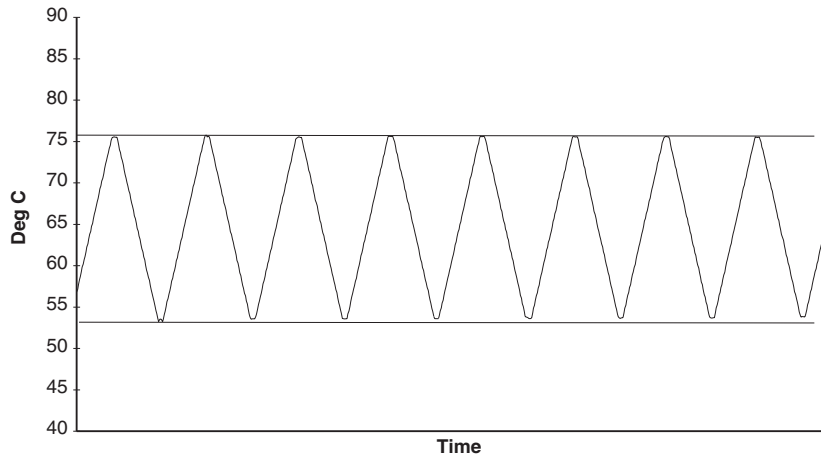

**Figure 7** Switch Test Data

## 8.6 Ramp and Soak Program Menu

The ramp and soak program feature allows the user to program a number of set-points and have the dry-well automatically cycle between the temperatures, holding at each for a determined length of time. The user can select one of four different cycle functions.

The program parameter menu is accessed by pressing “SET” and then “UP”.

20.00 C Well temperature

SET + UP Access program menu

P r o G Program menu

Press “SET” to enter the program menu

SET Enter program menu

### 8.6.1 Number of Program Set-points

The first parameter in the program menu is the number of set-points to cycle through. Up to 8 set-points can be used in a ramp and soak program.

P n = 8 Number of program set-points

Use the “UP” or “DOWN” buttons to change the number from 2 to 8.

 *New number of program set-points*

Press “SET” to continue. Pressing “EXIT” will cause any changes made to the parameter to be ignored.



*Save new setting*

## 8.6.2 Set-points

The next parameters are the program set-points.

 *First set-point*

Use the “UP” or “DOWN” buttons to select any of the set-points.

 *Third set-point*

Press “SET” to change the set-point.

 *Set-point value*

Use “UP” and “DOWN” to change the set-point value.

 *New set-point value*

Press “SET” to save the new set-point value.

The other set-points can also be set in the same manner. Once the set-points are programmed as desired press “EXIT” to continue.



*Continue to next menu function*

## 8.6.3 Program Soak Time

The next parameter in the program menu is the soak time. This is the time, in minutes, for which each of the program set-points will be maintained after settling before proceeding to the next set-point. The duration is counted from the time the temperature settles to within a specified stability. The stability requirement can be set in the parameter menu as explained in Section 8.11.2.3. The default is 0.1°C.

 *Soak time in minutes*

Use the “UP” or “DOWN” buttons to change the time.

 *New soak time*

Press “SET” to continue.



*Save new setting*

## 8.6.4 Program Function Mode

The next parameter is the program function or cycle mode. There are four possible modes which determine whether the program will scan up (from set-point 1 to n) only or both up and down (from set-point n to 1), and also whether the program will stop after one cycle or repeat the cycle indefinitely. The table below shows the action of each of the four program mode settings.

Function	Action
1	up-stop
2	up-down-stop
3	up-repeat
4	up-down-repeat

$P F = 1$  *Program mode*

Use the “UP” or “DOWN” buttons to change the mode.

$P F = 4$  *New mode*

Press “SET” to continue.



*Save new setting*

## 8.6.5 Program Control

The final parameter in the program menu is the control parameter. You may choose between three options to either start the program from the beginning, continue the program from where it was when it was stopped, or stop the program.

$P r = 0 F F$  *Program presently off*

Use the “UP” or “DOWN” buttons to change the status.

$P r = 5 E R r E$  *Start cycle from beginning*

Press “SET” to activate the new program control command and return to the temperature display.



*Activate new command.*

## 8.7 Secondary Menu

Functions which are used less often are accessed within the secondary menu. *The secondary menu is accessed by pressing “SET” and “EXIT” simultaneously and then releasing.* The first function in the secondary menu is the heater power display.

## 8.8 Heating Power

The temperature controller controls the temperature of the well by heating or cooling the well with the thermoelectric modules. The amount of heating or cooling power depends on the temperature set-point of the well. This heating (or cooling) power value may be estimated by watching the red/green control indicator light or read directly from the digital display. By knowing the amount of heating the user can tell if the calibrator is heating up to the set-point, cooling down, or controlling at a constant temperature. Monitoring the percent heater power will let the user know how stable the well temperature is. With good control stability the percent heating power should not fluctuate more than  $\pm 1\%$  within one minute.

The heater power display is accessed in the secondary menu. Press “SET” and “EXIT” simultaneously and release. The heater power will be displayed as a percentage of full power.

 *Well temperature*

 +  *Access heater power in secondary menu*

 *Heater power in percent*

Negative numbers indicate the well is being cooled. -100% means the well is being cooled at maximum power. 0 means the well requires neither heating nor cooling. 100% means the well is being heated at maximum power.

To exit out of the secondary menu press “EXIT”. To continue on to the proportional band setting function press “SET”.

## 8.9 Proportional Band

In a proportional controller such as this, the heater output power is proportional to the well temperature over a limited range of temperatures around the set-point. This range of temperature is called the proportional band. At the bottom of the proportional band the heating is 100%. At the top of the proportional

band the cooling is 100%. Thus as the temperature rises the heater power is reduced, which consequently tends to lower the temperature back down. In this way the temperature is maintained at a fairly constant temperature.

The temperature stability of the well and response time depend on the width of the proportional band. See Figure 8 on page 35. If the band is too wide the well temperature will deviate excessively from the set-point due to varying external conditions. This is because the power output changes very little with temperature and the controller cannot respond very well to changing conditions or noise in the system. If the proportional band is too narrow the temperature may swing back and forth because the controller overreacts to temperature variations. For best control stability the proportional band must be set for the optimum width.

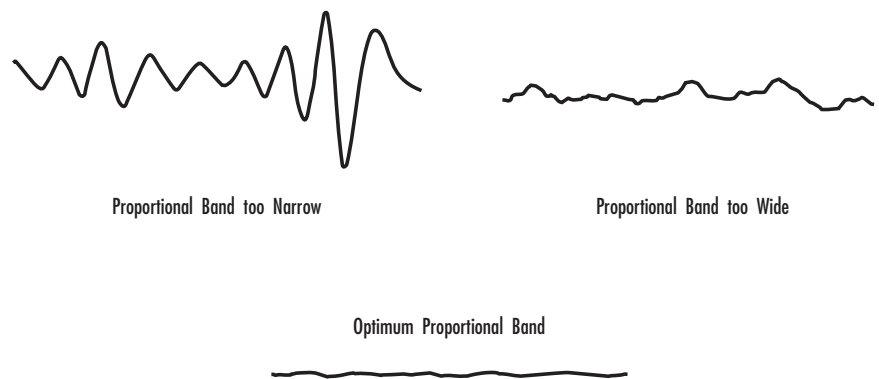

**Figure 8** Well temperature fluctuation at various proportional band settings

The proportional band width is set at the factory to about 2.0°C. The proportional band width may be altered by the user if he desires to optimize the control characteristics for a particular application.

The proportional band width is easily adjusted from the front panel. The width may be set to discrete values in degrees C or F depending on the selected units. The proportional band adjustment is accessed within the secondary menu. Press “SET” and “EXIT” to enter the secondary menu and show the heater power. Then press “SET” to access the proportional band.

SET + EXIT    Access heater power in secondary menu  
-12 Pct    Heater power in percent

SET    Access proportional band



 *Proportional band setting*

To change the proportional band press “UP” or “DOWN”.

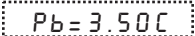
 *New proportional band setting*

To accept the new setting and access the cut-out set-point press “SET”.  
Pressing “EXIT” will exit the secondary menu ignoring any changes just made to the proportional band value.



*Accept the new proportional band setting*

## 8.10 Cut-out

As a protection against software or hardware fault or user error, the calibrator is equipped with an adjustable cut-out device that will shut off power to the heater if the well temperature exceeds a set value. This protects the instrument and probes from excessive temperatures. The cut-out temperature is programmable by the operator from the front panel of the controller.

If the cut-out is activated because of excessive well temperature then power to the heater will be shut off and the instrument will cool. The well will cool until it reaches a few degrees below the cut-out set-point temperature. At this point the action of the cut-out is determined by the setting of the cut-out mode parameter. The cut-out has two modes — automatic reset or manual reset. If the mode is set to automatic, then the cut-out will automatically reset itself when the temperature falls below the reset temperature allowing the well to heat up again. If the mode is set to manual, then the heater will remain disabled until the user manually resets the cut-out.

The cut-out set-point may be accessed within the secondary menu. Press “SET” and “EXIT” to enter the secondary menu and show the heater power. Then press “SET” twice to access the cut-out set-point.



+



*Access heater power in secondary menu*

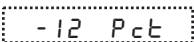

*Heater power in percent*



*Access proportional band*

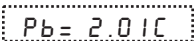

*Proportional band setting*



*Access cut-out set-point*

 *Cut-out set-point*

To change the cut-out set-point press “UP” or “DOWN”.

 *New cut-out set-point*

To accept the new cut-out set-point press “SET”.



*Accept cut-out set-point*

The next function is the configuration menu. Press “EXIT” to resume displaying the well temperature.

## 8.11 Controller Configuration

The controller has a number of configuration and operating options and calibration parameters that are programmable via the front panel. *These are accessed from the secondary menu after the cut-out set-point function by pressing “SET”.* There are 5 sets of configuration parameters—probe parameters, operating parameters, serial interface parameters, IEEE-488 interface parameters, and controller calibration parameters. *The menus are selected using the “UP” and “DOWN” keys and then pressing “SET”.*

### 8.11.1 Probe Parameters

The probe parameter menu is indicated by,

 *Probe parameters menu*

Press “SET” to enter the menu. The probe parameters menu contains the parameters,  $R_0$  and ALPHA, DELTA, and BETA which characterize the resistance-temperature relationship of the platinum control probe. These parameters may be adjusted to improve the accuracy of the calibrator. This procedure is explained in detail in Section 10.

*The probe parameters are accessed by pressing “SET” after the name of the parameter is displayed.* The value of the parameter may be changed using the “UP” and “DOWN” buttons. After the desired value is reached press “SET” to set the parameter to the new value. Pressing “EXIT” will cause the parameter to be skipped ignoring any changes that may have been made.

#### 8.11.1.1 R

This probe parameter refers to the resistance of the control probe at 0°C. The value of this parameter is set at the factory for best instrument accuracy.

**8.11.1.2 ALPHA**

This probe parameter refers to the average sensitivity of the probe between 0 and 100°C. The value of this parameter is set at the factory for best instrument accuracy.

**8.11.1.3 DELTA**

This parameter relates to the second order nonlinearity of the sensor. The value is set at the factory for best instrument accuracy.

**8.11.1.4 BETA**

This parameter relates to the higher order nonlinearity of the sensor below 0°C. The value is set at the factory for best instrument accuracy.

**8.11.2 Operating Parameters**

The operating parameters menu is indicated by,

 *Operating parameters menu*

Press “UP” to enter the menu. The operating parameters menu contains the units scale selection set and cut-out reset mode setting.

**8.11.2.1 Temperature Scale Units**

The temperature scale units of the controller may be set by the user to degrees Celsius (°C) or Fahrenheit (°F). The units will be used in displaying the well temperature, set-point, proportional band, and cut-out set-point.

The temperature scale units selection is the first function in the operating parameters menu.

 *Scale units currently selected*

Press “UP” or “DOWN” to change the units.

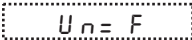
 *New units selected*

Press “SET” to accept the new selection and resume displaying the well temperature.

**8.11.2.2 Cut-out Reset Mode**

The cut-out reset mode determines whether the cut-out resets automatically when the well temperature drops to a safe value or must be manually reset by the operator.

The parameter is indicated by,

`CtOrSt` *Cut-out reset mode parameter*

Press “SET” to access the parameter setting. Normally the cut-out is set for automatic mode.

`CtO=Auto` *Cut-out set for automatic reset*

To change to manual reset mode press “UP” and then “SET”.

`CtO=rSt` *Cut-out set for manual reset*

### 8.11.2.3 Soak Stability

The soak stability controls the required stability of the well temperature for the soak time (Section 8.6.3). The stability is in degrees Celsius. The default is 0.1°C. This value can be changed in the parameter menu.

## 8.11.3 Serial Interface Parameters

The serial RS-232 interface parameters menu is indicated by,

`SERIAL` *Serial RS-232 interface parameters menu*

The serial interface parameters menu contains parameters which determine the operation of the serial interface. These controls only apply to instruments fitted with the serial interface. The parameters in the menu are — BAUD rate, sample period, duplex mode, and linefeed.

### 8.11.3.1 BAUD Rate

The BAUD rate is the first parameter in the menu. The BAUD rate setting determines the serial communications transmission rate.

The BAUD rate parameter is indicated by,

`BAUD` *Serial BAUD rate parameter*

Press “SET” to choose to set the BAUD rate. The current BAUD rate value will then be displayed.

`1200 b` *Current BAUD rate*

The BAUD rate of the serial communications may be programmed to 300, 600, 1200, or 2400 BAUD. Use “UP” or “DOWN” to change the BAUD rate value.

`2400 b` *New BAUD rate*

Press “SET” to set the BAUD rate to the new value or “EXIT” to abort the operation and skip to the next parameter in the menu.

### 8.11.3.2 Sample Period

The sample period is the next parameter in the serial interface parameter menu. The sample period is the time period in seconds between temperature measurements transmitted from the serial interface. For example, if the sample rate is set to 5, the instrument transmits the current measurement over the serial interface approximately every five seconds. The automatic sampling is disabled with a sample period of 0. The sample period is indicated by,

`SAMPLE` *Serial sample period parameter*

Press “SET” to choose to set the sample period. The current sample period value will be displayed.

`SA = 1` *Current sample period (seconds)*

Adjust the value with “UP” or “DOWN” and then use “SET” to set the sample rate to the displayed value.

`SA = 50` *New sample period*

### 8.11.3.3 Duplex Mode

The next parameter is the duplex mode. The duplex mode may be set to full duplex or half duplex. With full duplex any commands received by the calibrator via the serial interface are immediately echoed or transmitted back to the device of origin. With half duplex the commands are executed but not echoed. The duplex mode parameter is indicated by,

`dUPL` *Serial duplex mode parameter*

Press “SET” to access the mode setting.

`dUP = FULL` *Current duplex mode setting*

The mode may be changed using “UP” or “DOWN” and pressing “SET”.

`dUP = HALF` *New duplex mode setting*

### 8.11.3.4 Linefeed

The final parameter in the serial interface menu is the linefeed mode. This parameter enables (on) or disables (off) transmission of a linefeed character (LF, ASCII 10) after transmission of any carriage-return. The linefeed parameter is indicated by,

`LF` *Serial linefeed parameter*

Press “SET” to access the linefeed parameter.

`LF = 00` *Current linefeed setting*

The mode may be changed using “UP” or “DOWN” and pressing “SET”.

`LF = 0FF` *New linefeed setting*

### 8.11.4 IEEE-488 Parameters

The calibrator may optionally be fitted with an IEEE-488 GPIB interface. In this case the user may set the interface address within the IEEE-488 parameter menu. This menu does not appear on instruments not fitted with the interface. The menu is indicated by,

`IEEE` *IEEE-488 parameters menu*

Press “SET” to enter the menu.

#### 8.11.4.1 IEEE-488 Address

The IEEE-488 interface must be configured to use the same address as the external communicating device. The address is indicated by,

`Addr = 55` *IEEE-488 interface address*

Press “SET” to access the address setting.

`Addr = 22` *Current IEEE-488 interface address*

Adjust the value with “UP” or “DOWN” and then use “SET” to set the address to the displayed value.

`Addr = 15` *New IEEE-488 interface address*

#### 8.11.4.2 Termination

The next parameter in the menu is the transmission termination character selection. The parameter is indicated on the display by “EOS”. It can be set to carriage return only (Cr), linefeed only (LF), or carriage return and linefeed. Regardless of the option selected the instrument interprets either a carriage return or linefeed as a command termination during reception.

## 8.11.5 Calibration Parameters

The user has access to a number of the instrument calibration constants namely CTO, B0, and BG. These values are set at the factory and must not be altered. The correct values are important to the accuracy and proper and safe operation of the calibrator. Access to these parameters is available to the user only so that in the event that the controller's memory fails the user may restore these values to the factory settings. The user should have a list of these constants and their settings with the manual.



**CAUTION:** *DO NOT change the values of the calibration constants from the factory set values. The correct setting of these parameters is important to the safety and proper operation of the calibrator.*

The calibration parameters menu is indicated by,

 *Calibration parameters menu*

Press "SET" five times to enter the menu.

### 8.11.5.1 CTO

Parameter CTO sets the calibration of the over-temperature cut-out. This is not adjustable by software but is adjusted with an internal potentiometer. This parameter should read between 150 and 170.

### 8.11.5.2 B0 and BG

These parameters calibrate the accuracy of the temperature set-point. These are programmed at the factory when the instrument is calibrated. Do not alter the value of these parameters. If the user desires to calibrate the instrument for improved accuracy then calibrate R0 and ALPHA according to the procedure given in Section 10.

### 8.11.5.3 SCO

This parameter is used at the factory for testing purposes and should not be altered by the user.

## 9 Digital Communication Interface

The dry-well calibrator is capable of communicating with and being controlled by other equipment through the digital interface. Two types of digital interface are available — the RS-232 serial interface and the IEEE-488 GPIB interface.

With a digital interface the instrument may be connected to a computer or other equipment. This allows the user to set the set-point temperature, monitor the temperature, and access any of the other controller functions, all using remote communications equipment.

### 9.1 Serial Communications

The calibrator is installed with an RS-232 serial interface that allows serial digital communications over fairly long distances. With the serial interface the user may access any of the functions, parameters and settings discussed in Section 8 with the exception of the BAUD rate setting.

#### 9.1.1 Wiring

The serial communications cable attaches to the calibrator through the DB-9 connector at the back of the instrument. Figure 9 shows the pin-out of this connector and suggested cable wiring. To eliminate noise, the serial cable should be shielded with low resistance between the connector (DB9) and the shield.

#### 9.1.2 Setup

Before operation the serial interface must first be set up by programming the BAUD rate and other configuration parameters. These parameters are programmed within the serial interface menu. The serial interface parameters menu is outlined in Figure 6.

To enter the serial parameter programming mode first press

#### RS-232 Cable Wiring for IBM PC and Compatibles

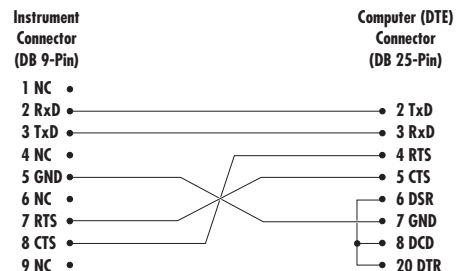
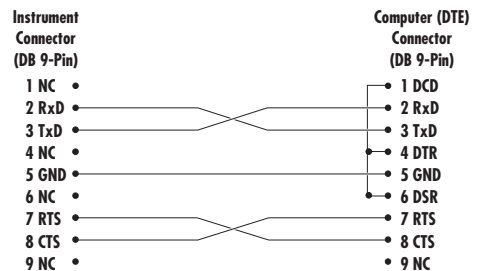

Figure 9 Serial Cable Wiring Diagram



“EXIT” while pressing “SET” and release to enter the secondary menu. Press “SET” repeatedly until the display reads “ProbE”. This is the menu selection. Press “UP” repeatedly until the serial interface menu is indicated with “SERIAL”. Finally press “SET” to enter the serial parameter menu. In the serial interface parameters menu are the BAUD rate, the sample rate, the duplex mode, and the linefeed parameter.

### **9.1.2.1 BAUD Rate**

The BAUD rate is the first parameter in the menu. The display prompts with the BAUD rate parameter by showing “BAUD”. Press “SET” to choose to set the BAUD rate. The current BAUD rate value is displayed. The serial communications BAUD rate may be programmed to 300, 600, 1200, or 2400 BAUD. The BAUD rate is pre-programmed to 1200 BAUD. Use “UP” or “DOWN” to change the BAUD rate value. Press “SET” to set the BAUD rate to the new value or “EXIT” to abort the operation and skip to the next parameter in the menu.

### **9.1.2.2 Sample Period**

The sample period is the next parameter in the menu and prompted with “SAMPLE”. The sample period is the time period in seconds between temperature measurements transmitted from the serial interface. If the sample rate is set to 5, the instrument transmits the current measurement over the serial interface approximately every five seconds. The automatic sampling is disabled with a sample period of 0. Press “SET” to choose to set the sample period. Adjust the period with “UP” or “DOWN” and then use “SET” to set the sample rate to the displayed value.

### **9.1.2.3 Duplex Mode**

The next parameter is the duplex mode indicated with “”. The duplex mode may be set to half duplex (“HALF”) or full duplex (“FULL”). With full duplex any commands received by the thermometer via the serial interface are immediately echoed or transmitted back to the device of origin. With half duplex the commands are executed but not echoed. The default setting is full duplex. The mode may be changed using “UP” or “DOWN” and pressing “SET”.

### **9.1.2.4 Linefeed**

The final parameter in the serial interface menu is the linefeed mode. This parameter enables (“On”) or disables (“OFF”) transmission of a linefeed character (LF, ASCII 10) after transmission of any carriage-return. The default setting is with linefeed on. The mode may be changed using “UP” or “DOWN” and pressing “SET”.

### 9.1.3 Serial Operation

Once the cable has been attached and the interface set up properly the controller will immediately begin transmitting temperature readings at the programmed rate. The serial communications uses 8 data bits, one stop bit, and no parity. The set-point and other commands may be sent via the serial interface to set the temperature set-point and view or program the various parameters. The interface commands are discussed in section . All commands are ASCII character strings terminated with a carriage-return character (CR, ASCII 13).

## 9.2 IEEE-488 Communication

The IEEE-488 interface is available as an option. Instruments supplied with this option may be connected to a GPIB type communication bus which allows many instruments to be connected and controlled simultaneously. To eliminate noise, the GPIB cable should be shielded

### 9.2.1 Setup

To use the IEEE-488 interface first connect an IEEE-488 standard cable to the back of the calibrator. Next set the device address. This parameter is programmed within the IEEE-488 interface menu. The IEEE-488 interface parameters menu is outlined in Figure 6.

To enter the IEEE-488 parameter programming menu first press “EXIT” while pressing “SET” and release to enter the secondary menu. Press “SET” repeatedly until the display reaches “PrObE”. This is the menu selection. Press “UP” repeatedly until the IEEE-488 interface menu is indicated with “IEEE”. Press “SET” to enter the IEEE-488 parameter menu. The IEEE-488 menu contains the IEEE-488 address parameter.

#### 9.2.1.1 IEEE-488 Interface Address

The IEEE-488 address is prompted with “AddrESS”. Press “SET” to program the address. The default address is 22. Change the device address of the calibrator if necessary to match the address used by the communication equipment by pressing “UP” or “DOWN” and then “SET”.

### 9.2.2 IEEE-488 Operation

Commands may now be sent via the IEEE-488 interface to read or set the temperature or access other controller functions. All commands are ASCII character strings and are terminated with a carriage-return (CR, ASCII 13). Interface commands are listed below.

## 9.3 Interface Commands

The various commands for accessing the calibrator functions via the digital interfaces are listed in this section (see Table 2 starting on page 47). These commands are used with both the RS-232 serial interface and the IEEE-488 GPIB interface. In either case the commands are terminated with a carriage-return character. The interface makes no distinction between upper and lower case letters, hence either may be used. Commands may be abbreviated to the minimum number of letters which determines a unique command. A command may be used to either set a parameter or display a parameter depending on whether or not a value is sent with the command following a “=” character. For example “s”<CR> returns the current set-point and “s=50.00”<CR> sets the set-point to 50.00 degrees.

In the following list of commands, characters or data within brackets, “[” and “]”, are optional for the command. A slash, “/”, denotes alternate characters or data. Numeric data, denoted by “n”, may be entered in decimal or exponential notation. Spaces may be added within command strings and will simply be ignored. Backspace (BS, ASCII 8) may be used to erase the previous character. A terminating CR is implied with all commands.

Table 2 Communications Commands

Command Description	Command Format	Command Example	Returned	Returned Example	Acceptable Values
<b>Display Temperature</b>					
Read current set-point	s[etpoint]	s	set: 9999.99 {C or F}	set: 150.00 C	
Set current set-point to <i>n</i>	s[etpoint]= <i>n</i>	s=450			Instrument Range
Read scan function	sc[an]	sc	scan: {ON or OFF}	scan: ON	
<b>Set scan function:</b>	<b>sc[an]=on/off</b>				ON or OFF
Turn scan function on	sc[an]=on	sc=on			
Turn scan function off	sc[an]=off	sc=of			
Read scan rate	sr[ate]	sr	srat: 999.99 {C or F}/min	srat: 10.0 C/min	
Set scan rate to <i>n</i> degrees per minute	sr[ate]= <i>n</i>	sr=5			.1 to 100°C
Read display temperature hold status	hm[ode]	hm	hm: {OFF or AUTO or NO or NC}		
<b>Set display temperature hold mode:</b>	<b>hm[ode]=OF[F]/AU[TO]/N O/NC</b>				OFF or AUTO or NO or NC
Set hold mode to off	hm[ode]=OF[F]	hm=of			
Set hold mode to automatic	hm[ode]=AU[TO]	hm=auto			
Set hold mode to normally open	hm[ode]=NO	hm=no			
Set hold mode to normally closed	hm[ode]=NC	hm=nc			
Read temperature	t[emperature]	t	t: 9999.99 {C or F}	t: 55.69 C	
Read hold status	ho[ld]	ho	ho: {Closed or Open}, 9999.99 {C or F}	ho: Open, 75.0 C	
<b>Secondary Menu</b>					
Read proportional band setting	pr[op-band]	pr	pb: 999.9	pb: 15.9	
Set proportional band to <i>n</i>	pr[op-band]= <i>n</i>	pr=8.83			Depends on Configuration
Read cutout setting	c[utout]	c	c: 9999 {C or F}	c: 620 C, in	
<b>Set cutout setting:</b>	<b>c[utout]=<i>n</i>/r[eset]</b>				
Set cutout to <i>n</i> degrees	c[utout]= <i>n</i>	c=500			Temperature Range
Reset cutout now	c[utout]=r[eset]	c=r			
Read heater power (duty cycle)	po[wer]	po	p%: 9999	po: 1	
<b>Ramp and Soak Menu</b>					
Read number of programmable set-points	pn	pn	pn: 9	pn: 2	
Set number of programmable set-points to <i>n</i>	pn= <i>n</i>	pn=4			1 to 8
Read programmable set-point number <i>n</i>	ps <i>n</i>	ps3	ps <i>n</i> : 9999.99 {C or F}	ps1: 50.00 C	
Set programmable set-point number <i>n</i> to <i>n</i>	ps <i>n</i> = <i>n</i>	ps3=50			1 to 8, Instrument Range
Read program set-point soak time	pt	pt	ti: 999	ti: 5	
Set program set-point soak time to <i>n</i> minutes	pt= <i>n</i>	pt=5			0 to 500
Read program control mode	pc	pc	prog: {OFF or ON}	prog: OFF	
<b>Set program control mode:</b>	<b>pc=g[o]/s[top]/c[ont]</b>				GO or STOP or CONT
Start program	pc=g[o]	pc=g			
Stop program	pc=s[top]	pc=s			
Continue program	pc=c[ont]	pc=c			
Read program function	pf	pf	pf: 9	pf: 3	

## Communications Commands Continued

Command Description	Command Format	Command Example	Returned	Returned Example	Acceptable Values
Set program function to <i>n</i>	pf= <i>n</i>	pf=2			1 to 4
<b>Configuration Menu</b>					
<b>Probe Menu</b>					
Read RO calibration parameter	r[0]	r	r0: 999.999	r0: 100.578	
Set RO calibration parameter to <i>n</i>	r[0]= <i>n</i>	r=100.324			98.0 to 104.9
Read ALPHA calibration parameter	al[pha]	al	al: 9.9999999	al: 0.0038573	
Set ALPHA calibration parameter to <i>n</i>	al[pha]= <i>n</i>	al=0.0038433			.00370 to .00399
Read DELTA calibration parameter	de[lta]	de	de: 9.99999	de: 1.46126	
Set DELTA calibration parameter to <i>n</i>	de[lta]= <i>n</i>	de=1.45			0.0 to 2.9
Read BETA calibration parameter	be[ta]	be	be: 9.999	be: 0.342	
Set BETA calibration parameter to <i>n</i>	be[ta]= <i>n</i>	be=0.342			-100.0 to 100.0
<b>Operating Parameters Menu</b>					
<b>Set temperature units:</b>	<b>u[nits]=c/f</b>				C or F
Set temperature units to Celsius	u[nits]=c	u=c			
Set temperature units to Fahrenheit	u[nits]=f	u=f			
Read cutout mode	cm[ode]	cm	cm: {xxxx}	cm: AUTO	
<b>Set cutout mode:</b>	<b>cm[ode]=r[eset]/a[uto]</b>				RESET or AUTO
Set cutout to be reset manually	cm[ode]=r[eset]	cm=r			
Set cutout to be reset automatically	cm[ode]=a[uto]	cm=a			
Read approach setting	ap[proach]	ap	ap: 9	ap: 5	
Set approach setting to <i>n</i> degrees	ap[proach]= <i>n</i>	ap=1.5			0 to 20°C
Read stability	ts	ts	ts: 9.9	ts: 0.5	
Set soak stability to <i>n</i> degrees	ts= <i>n</i>	ts=.1			.01 to 4.99°C
<b>Serial Interface Menu</b>					
Read serial sample setting	sa[mple]	sa	sa: 9	sa: 1	
Set serial sampling setting to <i>n</i> seconds	sa[mple]= <i>n</i>	sa=0			0 to 4000
<b>Set serial duplex mode:</b>	<b>du[plex]=f[ull]/h[alf]</b>				FULL or HALF
Set serial duplex mode to full	du[plex]=f[ull]	du=f			
Set serial duplex mode to half	du[plex]=h[alf]	du=h			
<b>Set serial linefeed mode:</b>	<b>lf[eed]=on/off</b>				ON or OFF
Set serial linefeed mode to on	lf[eed]=on	lf=on			
Set serial linefeed mode to off	lf[eed]=off	lf=of			
<b>Calibration Menu (WARNING – changing the following calibration values may change the accuracy of the instrument.)</b>					
Read B0 calibration parameter	*b0	*b0	b0: 9	b0: 0	
Set B0 calibration parameter to <i>n</i>	*b0= <i>n</i>	*b0=0			-999.9 to 999.9
Read BG calibration parameter	*bg	*bg	bg: 999.99	bg: 15625	
Set BG calibration parameter to <i>n</i>	*bg= <i>n</i>	*bg=156.25			-999.9 to 999.9

## Communications Commands Continued

Command Description	Command Format	Command Example	Returned	Returned Example	Acceptable Values
<b>These commands are only used for factory testing.</b>					
Read software cutout mode	*sco	*sco	sco: {ON or OFF}	sco: ON	
<b>Set software cutout mode:</b>	<b>*sco=ON/OFF[F]</b>				ON or OFF
Set software cutout mode on	*sco=ON	*sco=on			
Set software cutout mode off	*sco=OFF[F]	*sco=off			
<b>Miscellaneous (not on menus)</b>					
Read firmware version number	*ver[sion]	*ver	ver.9999,9.99	ver.9105,3.54	
Read structure of all commands	h[elp]	h	list of commands		
Legend:	[] Optional Command data / Alternate characters or data {} Returns either information n Numeric data supplied by user — may be entered in decimal or exponential notation 9 Numeric data returned to user x Character data returned to user				
Note:	When DUPLEX is set to FULL and a command is sent to READ, the command is returned followed by a carriage return and linefeed. Then the value is returned as indicated in the RETURNED column.				

## 10 Test Probe Calibration

For optimum accuracy and stability, allow the calibrator to warm up for 10 minutes after power-up and then allow adequate stabilization time after reaching the set-point temperature. After completing calibration, allow the block to cool before switching the power off.

For information on automating your testing, contact Hart Scientific, Inc.

### 10.1 Comparison Methods

#### 10.1.1 Direct Calibration

Direct calibration involves testing a probe directly against the dry-well's temperature display. The method provides the advantage of being quick and easy.

Insert the probe to be calibrated into the well of the dry-well calibrator. The probe should fit snugly into the calibrator probe sleeve yet should not be so tight that it cannot be easily removed. Avoid any dirt or grit that may cause the probe to jam into the sleeve. Best results are obtained with the probe inserted to the full depth of the well. Once the probe is inserted into the well, allow adequate stabilization time to allow the test probe temperature to settle as described. Once the probe has settled to the temperature of the well, it may be compared to the calibrator display temperature. The display temperature should be stable to within 0.1°C for best results.



**Caution:** *Never introduce any foreign material into the probe hole of the insert. Fluids, etc., can leak into the calibrator causing damage to the calibrator or binding and damage to your probe.*

#### 10.1.2 Comparison Calibration

Comparison calibration involves testing a probe against a similar reference probe. The advantage to this method is that better accuracy can be achieved since errors due to dry-well inaccuracy, stem effect, and drift can be reduced.

After inserting the probes to be calibrated, allow sufficient time for the probes to settle and the temperature of the dry-well to stabilize.

Both the reference probe and the probe under test should be the same size and construction. Using probes with different lengths, diameters and materials will have different stem effects causing an unknown temperature difference. All dry-wells have horizontal and vertical gradients that change with temperature. This is an unknown variable which can be factored out if probes are the same

type, length, diameter, and material. Probes should be inserted to the same depth in the well.

The following procedure can be used to calibrate a probe against a reference while eliminating error due to temperature gradients between wells.

1. Place the reference probe in one well.
2. Place the probe to be calibrated, the unit under test (UUT), in another well.
3. With the reference inserted into one well and the probe under test inserted into a second well, make measurements of each.
4. Swap the locations of the reference probe and probe under test. Allow plenty of time for thermal settling.
5. Make another set of measurements of the reference probe and the probe under test.
6. Average the two measurements of the reference probe. Average the two measurements of the probe under test. Averaging the two measurements in this way eliminates error due to temperature gradients between the two wells.
7. You may now compare the averaged measurement of the probe under test with the averaged measurement of the reference probe.

For best results repeat the test several times at the same temperature and at different temperatures.

This method can be used with different types of probes but the user must determine the uncertainty of the measurement.

### **10.1.3 Calibration of Multiple Probes**

Fully loading the calibrator with probes increases the time required for the temperature to stabilize after inserting the probes. Be sure that the temperature has stabilized before starting the calibration.

Multiple probes may be calibrated simultaneously using either the direct or comparison calibration method. Stem effect will cause less error in the comparison calibration method than with the direct calibration method.

## **10.2 Dry-Well Characteristics**

Understanding the thermal characteristics of the dry-well calibrator can help you achieve the best accuracy and efficiency possible.



### 10.2.1 Vertical Gradient

There is a temperature gradient vertically in the test well. The heater has been applied to the block in such a way as to compensate for nominal heat losses out of the top of the dry-well and minimize vertical temperature gradients. However, actual heat losses will vary depending on the number and types of probes inserted into the calibrator and the block temperature. For best results, insert probes the full depth of well.

### 10.2.2 Stabilization and Accuracy

The stabilization time of the dry-well calibrator will depend on the conditions and temperatures involved. Typically, the dry-well will be stable to  $0.1^{\circ}\text{C}$  within 5 minutes of reaching the set-point temperature as indicated by the display. Ultimate stability will be achieved 10 to 20 minutes after reaching the set temperature.

Inserting a cold probe into a well will require another period of stabilization depending on the magnitude of the disturbance and the required accuracy. For example, inserting a  $\frac{1}{4}$  inch diameter room probe at temperature into a sleeve at  $300^{\circ}\text{C}$  will take approximately 5 minutes to be within  $0.1^{\circ}\text{C}$  of its set-point and will take 10 minutes to achieve maximum stability.

Decreasing the time required for the calibration process can be accomplished by knowing how soon to make the measurement. It is recommended that typical measurements be made at the desired temperatures with the desired test probes to establish these times.

# 11 Calibration Procedure

## 11.1 Calibration Procedure

Calibration of this instrument should be performed at regularly scheduled intervals by qualified authorized personnel in accordance with your company's policy. Following is the recommended procedure for calibrating this instrument.

### 11.1.1 Calibration Equipment

Calibration requires a standard thermometer that is adequately accurate and fits properly into one of the reference holes in the block. Recommended equipment includes a laboratory grade PRT with a length of 230 to 300 mm (9 to 12 inches) and a diameter of 4.76 or 6.35 mm (3/16 or 1/4 inches). The combined accuracy of the PRT and the readout which used to display the temperature should be 0.025°C or better.

### 11.1.2 Calibration

The accuracy of the instrument over the full range is determined by the values of the calibration parameters R0, ALPHA, DELTA, and BETA. The calibration procedure involves measuring the error between the instrument and the reference thermometer at several temperature throughout the range and adjusting the calibration parameters as necessary to reduce the errors to within acceptable limits. The stated accuracy of the instrument can be found in the specification table in Section 3.1. Because of the way the calibration parameters affect the temperature the simplest way to proceed is to measure the errors at 0°C, 100°C, 140°C, and -25°C and adjust R0, ALPHA, DELTA, and BETA at each point respectively. Follow these steps:

1. If "as found" data is required then first measure the error at various temperatures throughout the range such as -25, 0, 25, 50, 75, 100, and 140°C. The errors are measured by setting the controller to the desired temperature, allowing the block to reach the temperature and stabilize, and reading the actual temperature of the block with the standard thermometer. If the measured errors are all within acceptable limits then no further action is required and following the remainder of this procedure is not necessary. If the accuracy needs to be improved continue with Step 2.
2. Set the set-point to 0°C and allow adequate time for the block to reach this temperature and stabilize. Adjust the R0 calibration parameter (see Section 8.11.1.1) to make the block temperature as measured with the standard thermometer match the set-point. The approximate ratio between a change in R0 and a change in temperature at 0°C is about 0.4

to 1. For example, if the block temperature is high by  $0.1^{\circ}\text{C}$  at  $0^{\circ}\text{C}$  then decrease R0 by 0.04.

3. Set the set-point to  $100^{\circ}\text{C}$  and allow adequate time for the block to reach this temperature and stabilize. Adjust the ALPHA calibration parameter (see Section 8.11.1.2) to make the block temperature as measured with the standard thermometer match the set-point. The approximate ratio between a change in ALPHA and a change in temperature at  $100^{\circ}\text{C}$  is about 0.00004 to 1. For example, if the block temperature is high by  $0.1^{\circ}\text{C}$  at  $100^{\circ}\text{C}$  then decrease ALPHA by 0.000004.
4. Set the set-point to  $140^{\circ}\text{C}$  and allow adequate time for the block to reach this temperature and stabilize. Adjust the DELTA calibration parameter (see Section 8.11.1.3) to make the block temperature as measured with the standard thermometer match the set-point. The approximate ratio between a change in DELTA and a change in temperature at  $140^{\circ}\text{C}$  is about -1.7 to 1. For example, if the block temperature is high by  $0.1^{\circ}\text{C}$  at  $50^{\circ}\text{C}$  then increase DELTA by 0.17.
5. Set the set-point to  $-25^{\circ}\text{C}$  and allow adequate time for the block to reach this temperature and stabilize. Adjust the BETA calibration parameter (see Section 8.11.1.4) to make the block temperature as measured with the standard thermometer match the set-point. The approximate ratio between a change in BETA and a change in temperature at  $-25^{\circ}\text{C}$  is about -50 to 1. For example, if the block temperature is high by  $0.1^{\circ}\text{C}$  at  $-25^{\circ}\text{C}$  then increase BETA by 5.0.
6. Repeat Step 1 to ensure the instrument is now accurate throughout the full range.

# 12 Maintenance

- The calibration instrument has been designed with the utmost care. Ease of operation and simplicity of maintenance have been a central theme in the product development. Therefore, with proper care the instrument should require very little maintenance. Avoid operating the instrument in an oily, wet, dirty, or dusty environment.
- If the outside of the instrument becomes soiled, it may be wiped clean with a damp cloth and mild detergent. Do not use harsh chemicals on the surface which may damage the paint.
- It is important to keep the well of the calibrator clean and clear of any foreign matter. **DO NOT** use fluid to clean out the well.
- The dry-well calibrator should be handled with care. Avoid knocking or dropping the calibrator.
- For dry-wells with removable probe sleeves, the sleeves can become covered with dust and carbon material. If the buildup becomes too thick, it could cause the sleeves to become jammed in the wells. Avoid this buildup by periodically buffing the sleeves clean.
- If a sleeve should be dropped, examine the sleeve for deformities before inserting it in the well. If there is any chance of jamming the sleeve in the well, file or grind off the protuberance.
- **DO NOT** slam the probe stems into the well. This type of action can cause a shock to the sensor.
- If a hazardous material is spilt on or inside the equipment, the user is responsible for taking the appropriate decontamination steps as outlined by the national safety council with respect to the material.
- If the mains supply cord becomes damaged, replace it with a cord with the appropriate gauge wire for the current of the instrument. If there are any questions, call Hart Scientific Customer Service for more information.
- Before using any cleaning or decontamination method except those recommended by Hart, users should check with Hart Scientific Customer Service to be sure that the proposed method will not damage the equipment.
- If the instrument is used in a manner not in accordance with the equipment design, the operation of the dry-well may be impaired or safety hazards may arise.

- The over-temperature cut-out should be checked every 6 months to see that it is working properly. In order to check the user selected cut-out, follow the controller directions (Section 8.2) for setting the cut-out. Both the manual and the auto reset option of the cut-out should be checked. Set the instrument temperature higher than the cut-out. Check to see if the display flashes cut-out and the temperature is decreasing.

# 13 Troubleshooting

## 13.1 Troubleshooting

In the event that the dry-well appears to function abnormally, this section may help to find and solve the problem. Several possible problem conditions are described along with likely causes and solutions. If a problem arises, please read this section carefully and attempt to understand and solve the problem. If the dry-well seems faulty or the problem cannot otherwise be solved, contact Hart Scientific Customer Service for assistance (1-801-763-1600). Be sure to have the instrument model number, serial number, and voltage available.

Problem	Causes and Solutions
Incorrect temperature reading	Power the unit on and watch the display. If the first number displayed is less than “- 0 0 0 5-”, the unit has been re-initialized. The unit needs to be re-programmed for RO, ALPHA, and DELTA. These numbers can be found on the Report of Calibration that was shipped with the unit.
The display is off	Check the fuses. Check that the power cord is plugged in and connected to the unit.
Red LED on display is blank	Check that there is power to the unit.
The unit heats slowly	Check the Scan and Scan Rate settings. The Scan may be on with the Scan Rate set low.
An “o” or “c” is displayed at the left of the display	The external switch is open causing the displayed temperature to be frozen and keeping the set-point from scanning. Turn the Switch Test off by pressing the “DOWN” button on the front panel.
<b>If the display flashes any error code</b>	Initialize the system by performing the <b>Master Reset Sequence</b> . If the unit repeats the error code, contact a Hart Scientific Authorized Customer Service Center for a return authorization and for instructions on returning the unit.  <b>Master Reset Sequence:</b> Hold the “SET” and “EXIT” keys down at the same time while powering up the unit. The screen will display “- 1 0 1 6-”, the instrument model number and the version of the software. The unit will need to be reprogrammed for RO, ALPHA, and DELTA in the calibration menu. These numbers can be found on the Report of Calibration that was shipped with the unit.
If the display flashes “- 2 7 3° C” or “- 4 5 9° F”	The sensor is disconnected or shorted. Please contact Hart Scientific Customer Support for further instructions.
If the display flashes “c u t - o u t”	The software cut-out is set to low. Check the cut-out setting in the Set-point menu.

Problem	Causes and Solutions
Temperature readout is not the actual temperature of the well	With the unit stable, slowly rotate the unit. If no change occurs, the unit may need to be calibrated. Contact Hart Scientific Customer Service. If the display changes more than twice the normal display deviation, another unit in the area could be emitting RF energy. Move the unit to a different location and rotate the unit again. If the temperature is correct in this new area or deviates differently than the first area, RF energy is present in the room. If you have to perform the test in the effected area, use the comparison test to eliminate any possible errors.

## 13.2 Comments

### 13.2.1 EMC Directive

Hart Scientific's equipment has been tested to meet the European Electromagnetic Compatibility Directive (EMC Directive, 89/336/EEC). Selection of Light Industrial or Heavy Industrial compliance has been based on the intended use of the instrument. Units designed for use in a calibration laboratory have been tested to Light Industrial Standards. Units designed to be used in the "field" have been tested to both Light Industrial and Heavy Industrial Standards. The Declaration of Conformity for your instrument lists the specific standards to which the unit was tested.

### 13.2.2 Low Voltage Directive (Safety)

In order to comply with the European Low Voltage Directive (73/23/EEC), Hart Scientific equipment has been designed to meet the IEC 1010-1 (EN 61010-1) and the IEC 1010-2-010 (EN 61010-2-010) standards.

# 13.3 Wiring Diagrams

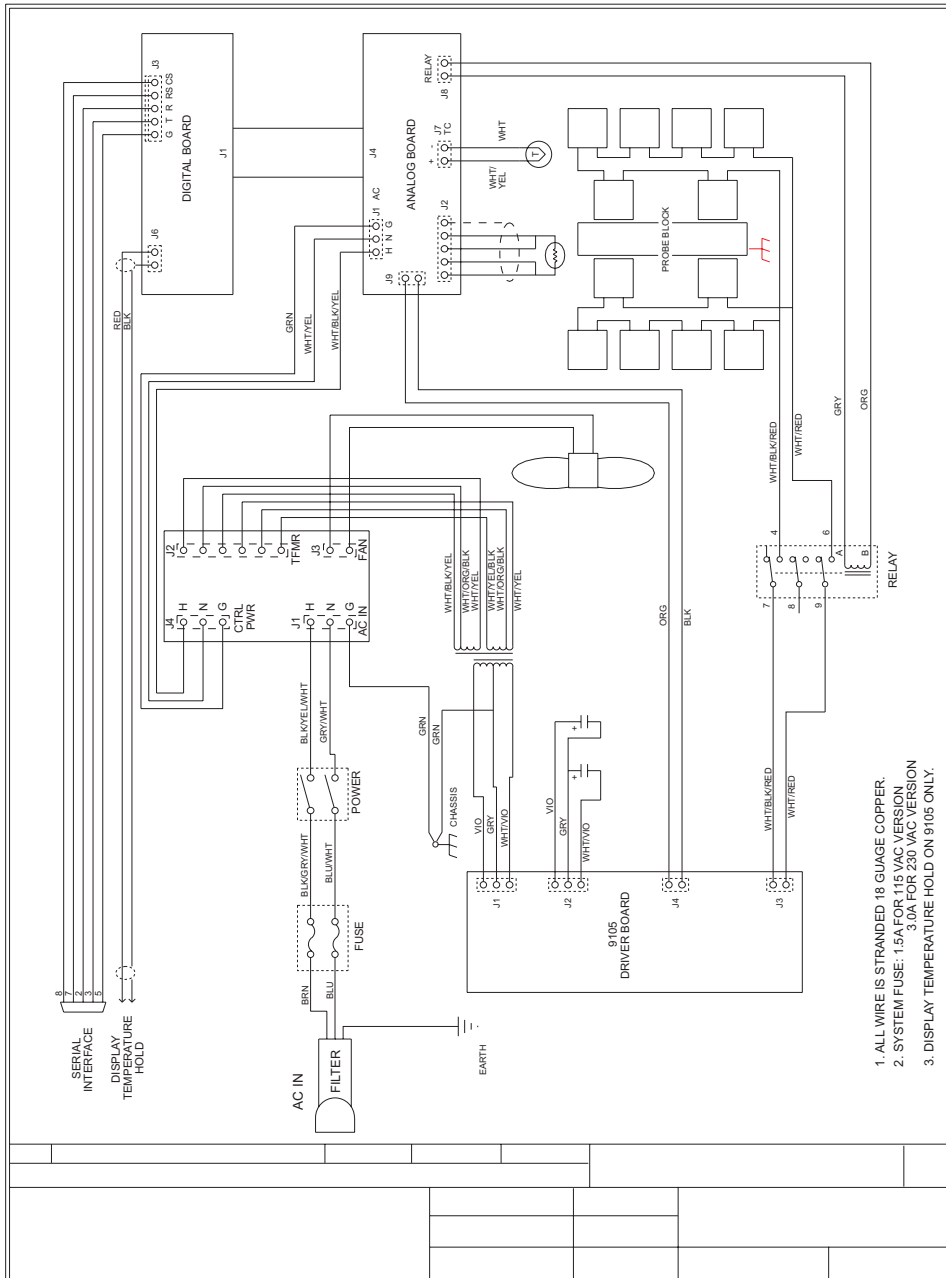

1. ALL WIRE IS STRANDED 18 GAUGE COPPER.
2. SYSTEM FUSE: 1.5A FOR 115 VAC VERSION  
3.0A FOR 230 VAC VERSION
3. DISPLAY TEMPERATURE HOLD ON 9105 ONLY.

Figure 10 9105 Wiring Diagram



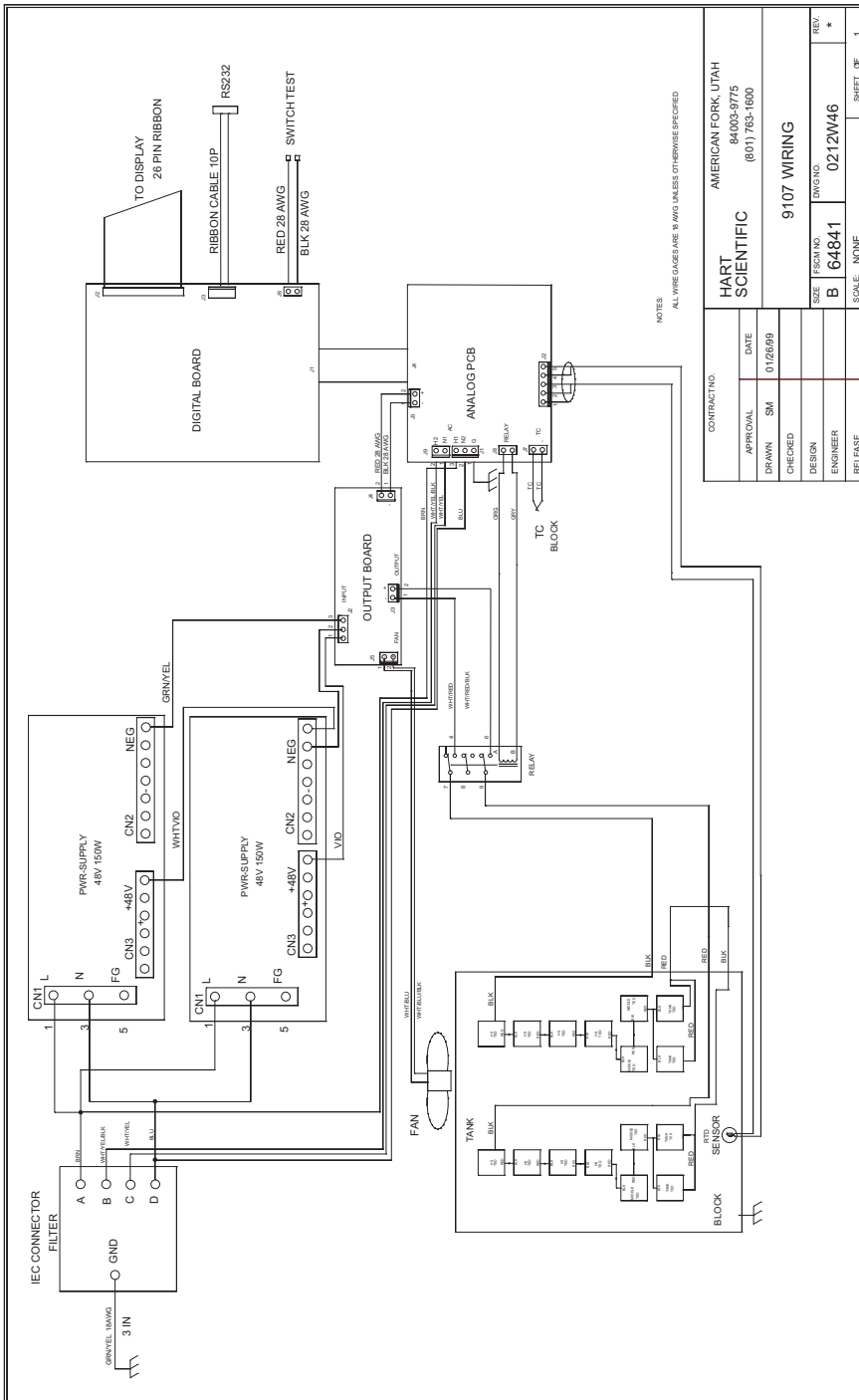

Figure 11 9107 Wiring Diagram